



# Lone Star

## M E T A L D E T E C T O R

### OWNER'S MANUAL

Your Lone Star Metal Detector is an advanced microprocessor-controlled metal detector. This motion detection system requires movement over an object in order for the machine to detect the object and emit a tone.

#### THE LONE STAR HAS TWO TYPES OF OPERATING MODES:

##### 1. ALL METAL DETECTION

All types of metals will be detected. From nails and property markers, to valuable treasure, all types of metal will induce a single tone.

##### 2. DISCRIMINATE, NOTCH, and AUTO NOTCH modes

Completely eliminate iron and trash items from detection in "DISC" mode, with the use of the DISC/NOTCH knob.

Automatically eliminate most pull tabs and trash items from detection in the AUTO NOTCH mode.

#### FOR OUTDOOR USE ONLY:

- If demonstrating indoors, beware of interference from electromagnetic fields.
- If interference occurs, the detector will chatter or beep erratically.
- To avoid interference, turn the sensitivity down.

#### **DO NOT TEST ON THE FLOOR**

*Most floors contain metal, which will interfere with the target's signal.*

# INTRODUCTION

The Lone Star is an advanced technology metal detector, designed for a variety of applications including coinshooting, relic hunting, and general purpose detecting.

Before using your Lone Star, it is important to read these instructions. This manual's description of detection concepts and types of metals is necessary to avoid frustration if you are new to the hobby of metal detecting.

## Terminology

**Elimination** — Reference to a metal or target being "eliminated" means that the detector will not emit a tone nor light up an LCD indicator when an object is in the coil's detection field.

**Discrimination** — When the detector emits different tones for different types of metals, and when the detector "eliminates" certain metals, we refer to this as the detector "discriminating" among different types of objects.

**Iron** — Iron is a common, low-grade metal which is often an undesirable target. Examples of undesirable iron objects are old cans, pipes, bolts, and nails.

**Relic** — A relic is an aged object of historical significance. Note that many relics are made of iron, an otherwise undesirable object in some metal detecting applications.

**Pull-tabs and Trash Items** — Discarded pull-tabs from beverage containers are the most bothersome items for professional and hobby metal detectorists. These items are generally constructed of aluminum, iron, or steel. We have therefore incorporated special features into the Lone Star to eliminate these targets or to alert you to their possible presence.

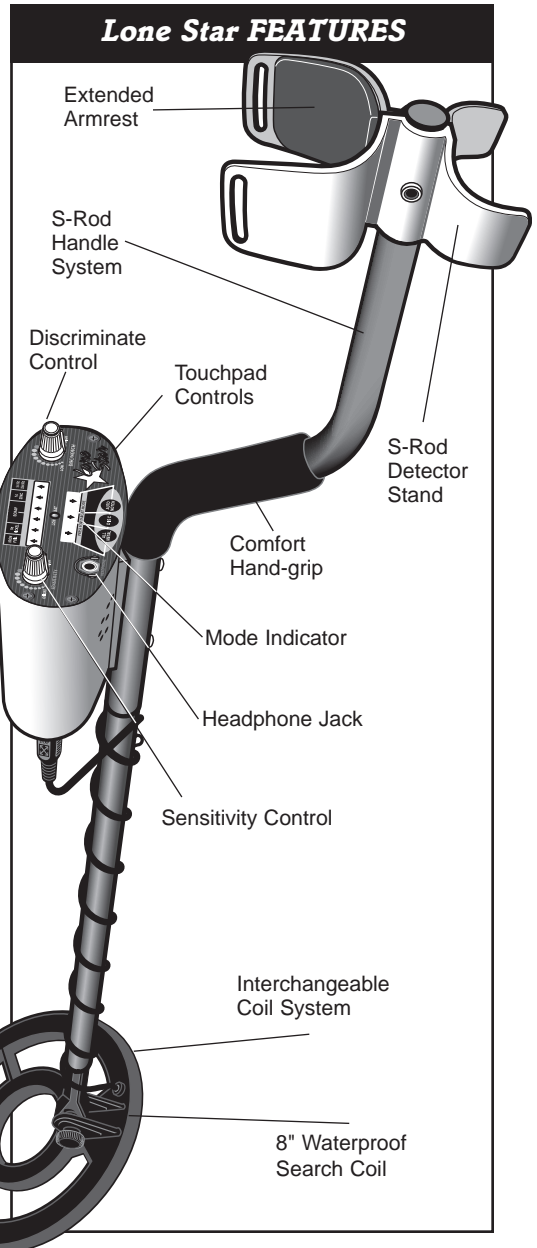

# EASY ASSEMBLY

**Assembling your Lone Star Metal Detector is easy and requires no tools. Just follow these steps:**

- 1 Using the supplied bolt and knurled knob, attach the search coil to the lower stem.
- 2 Press the button on the upper end of the lower stem and slide the lower stem into the upper stem.

Adjust the stem to a length that lets you maintain a comfortable upright posture, with your arm relaxed at your side.

- 3 Wind the search coil cable around the stem. Leave enough slack in the cable to let you adjust the coil when you are hunting on uneven ground. Then tighten the knob at the end of the search coil.

**Note:** To adjust the coil, simply loosen the knob.

- 4 Insert the coil's plug into the matching connector on the control housing. Be sure the holes and pins line up correctly.

## Caution:

- Do not force the plug in. Excess force will cause damage.
- To disconnect the cable, pull on the plug. Do not pull on the cable.

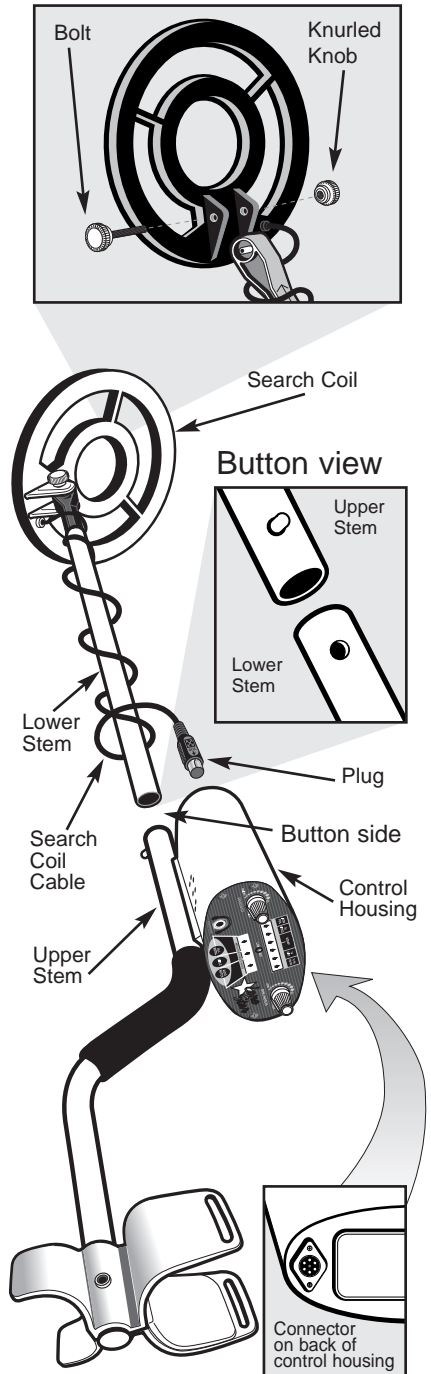

# BATTERIES

**IMPORTANT:** Always use **ALKALINE** batteries only.

Do not use heavy duty batteries.

Always remove the batteries for prolonged storage.

**CHECK THE BATTERIES** if your detector exhibits any of the following symptoms:

- ❶ The unit does not turn on.
- ❷ Low speaker volume.
- ❸ Unit beeps continuously or erratically.

The Low Battery indicator light will come on and stay on whenever the batteries need replacing. It should flash momentarily when the Power Switch is turned off. The flashing indicator tells you that your batteries are in good condition.

**IMPORTANT:** Your Lone Star metal detector requires two 9-Volt **ALKALINE** batteries.

*Follow these steps to install the batteries.*

- ❶ Carefully remove the battery compartment door by pressing the release clip on the right side of the door.
- ❷ Snap one battery onto each of the terminals and place the batteries inside the compartment.

Insert both of the batteries with terminals facing inward.

- ❸ Replace the compartment door by carefully inserting opposite side of clip first. Then press down on clip side until battery door snaps into place.

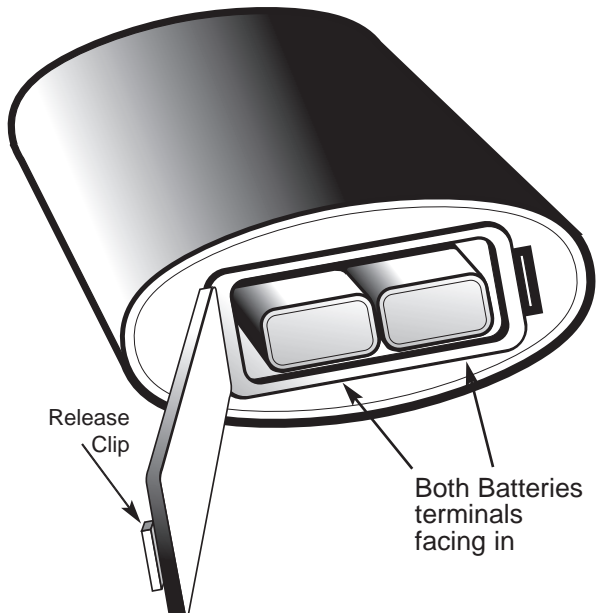

# LONE STAR DEMONSTRATION

Here is a quick way to demonstrate the basic features of the Lone Star.

## I. Supplies Needed

- A quarter (25¢)
- A penny (1¢ - Post 1982)
- A dime (10¢)
- A nickel (5¢)
- Small piece of aluminum foil
- A nail

## II. Position your Lone Star

- Place the detector on a table, with the search coil hanging over the edge.
- Be sure that the search coil is far away from walls or metal objects. Keep the search coil away from any metal in the table.
- **Turn off appliances or lights which cause electromagnetic interference**

## III. Beginning Switch Settings

- Right Knob (DISC/NOTCH) — 100% counterclockwise to low
- Left Knob (SENSITIVITY) — click on and set to 3:00 (3/4 turn)
- Do not press any touchpads

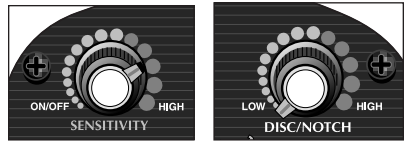

## IV. All Metal Detection

- A. Wave all objects under the search coil
  - NOTICE THE SINGLE TONE

## V. Discriminate Mode

- A. Press the DISC touchpad
- B. Turn the right knob (DISC/NOTCH) to the 12:00 position.
- C. Wave all objects under the search coil.
  - NOTICE THE DIFFERENT TONES
  - NOTICE THE METALS ELIMINATED
- D. Move the DISC/NOTCH control to different positions and eliminate the penny from detection.

## VI. Auto Notch Mode

- A. Press the AUTO NOTCH touchpad
- B. Right knob (DISC/NOTCH) 100% counterclockwise to low
- C. Wave all objects under the search coil while slowly turning the right knob clockwise.
  - NOTICE THE DIFFERENT TONES
  - NOTICE THE METALS ELIMINATED

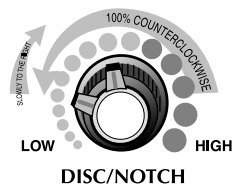
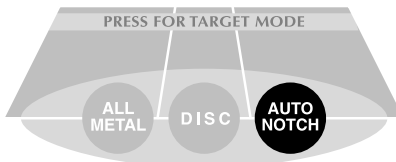

# BASIC OPERATION

## TURNING ON YOUR DETECTOR

Turn the left knob (SENSITIVITY) to the right. As the knob clicks to the "On" position, the detector sounds three tones, the LCD arrows appear momentarily, and the unit pre-sets to the ALL METAL mode of operation.

## SET THE MODE

### 1. ALL METAL

- Press the ALL METAL touchpad

The unit will emit sound when passing over all types of metal objects. The ALL METAL mode offers the greatest depth detection capability.

### 2. DISCRIMINATE

- A. Press the DISC touchpad
- B. Slowly turn the right knob (DISC/NOTCH) clockwise.

All iron or ferrous objects are eliminated from detection. As you turn the DISC/NOTCH knob clockwise you can eliminate foil, pull tabs, screw caps, and zinc pennies.

### 3. AUTO NOTCH

Press the AUTO NOTCH touchpad, and the detector will automatically reject iron and most pull-tabs. Nickels and many small gold rings will be retained. The DISC/NOTCH knob creates a rejection "window" which can be moved as it is turned clockwise. With this mode, you can reject screw caps and zinc (post 1982) pennies as the DISC/NOTCH control is turned clockwise, but still detect valuables with low and high tones.

**Note:** If you are not sure of your current mode setting, simply press the desired touch-pad again.

## USING HEADPHONES

Using headphones (not supplied) improves battery life, and prevents the sounds from annoying bystanders.

It also allows you to hear subtle changes in the sound more clearly, particularly if searching in a noisy location. For safety reasons, do not use headphones near traffic or where other dangers are present. This device is to be used with interconnecting cables/headphone cables shorter than three meters.

# LCD TARGET DISPLAY

***Please refer to the display on your detector and reference the TARGET I.D. categories below applicable to your model (not all detectors include all of these categories).***

## READING THE DISPLAY

The Liquid Crystal Display (LCD) shows the PROBABLE identification of the targeted metal, as well as the PROBABLE depth of the target.

The detector will register a consistent target identification, upon each sweep of the coil, when a buried target has been located and identified. If, upon repeated passes over the same spot, the target identification reads inconsistently, the target is probably a trash item, or oxidized metal. With practice, you will learn to unearth only the repeatable signals.

The segment identifications are highly accurate, when detecting the objects described on the label. However, if an object registers in a given category for an unknown buried object, you could be detecting a metallic object other than the object described on the label, but with the same metallic signature. Also, the greater the distance between the target and the coil, the less accurate the target identification.

**GOLD TARGETS** Gold objects will register toward the middle or left-of-center on the LCD scale.

**Gold flakes** may register under iron.

**Small gold items** may register under foil or 5¢.

**Large gold items** will register toward the center of the scale.

**SILVER TARGETS:** Silver objects will register to the right of the scale, under dime or higher.

**IRON:** All sizes of iron objects will register on the far-left side of the scale. This could indicate a worthless item

such as a nail, or a more valuable historic iron relic.

**FOIL:** Aluminum foil, such as a gum wrapper, will register as foil. A small broken piece of pull tab may also register here.

**5¢:** Most newer pull-tabs from beverage cans, the type intended to stay attached to the can, will register here. Many gold rings will also register here.

**ALUM:** Older pull tabs, which always detached completely from the can, register here. Many medium size gold ring also register here.

**PT(pull-tabs):** Pull-tabs from older beverage cans will register here. Few newer pull-tabs will also register here. Many gold rings will also register here.

**S-CAP:** Older screw caps from glass bottles will register here. Large gold rings, like a class ring, could also register here. Some non-U.S. coins of recent vintage will also register here.

**Zinc:** Medium conductivity objects and many non-U.S. coins of recent vintage are classified here.

The Target Identification Categories to the right of the display, such as copper coins, 10¢, DIME, 25¢, Quarter, 50¢, \$1 accurately identify these U.S. coins. When used in areas outside the U.S., these categories identify coins or metal objects of high relative conductivity (such as silver coins or relics), or large objects made of any type of metal.

**Caution:** The target indications are visual references. Many other types of metal can fall under any one of these categories. While the detector will eliminate or indicate the presence of most common trash items, it is impossible to accurately classify ALL buried objects.

# SENSITIVITY ADJUSTMENT

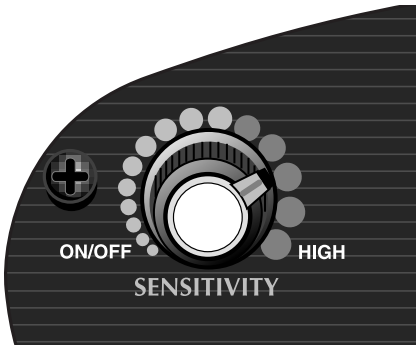

The principle use for the SENSITIVITY knob is to eliminate ELECTROMAGNETIC INTERFERENCE (EMI). EMI is both naturally-occurring and man-made. Common sources of EMI are power lines, both suspended and buried, and broadcasting antennas. Machinery, when in operation, can also produce EMI.

EMI comes from most household appliances, so **YOUR DETECTOR CAN BEHAVE VERY ERRATICALLY INDOORS.** If you want to test it indoors, turn off the TV and microwave. If you have lights with

dimmer switches, also turn these off; dimmer switches can produce lots of EMI.

If your detector chatters with the SENSITIVITY knob in the 100% clockwise position, reduce the sensitivity until the chatter stops (usually to the 1:00 or 3:00 position).

If you suspect the presence of deeper targets underneath a shallower target, reduce the SENSITIVITY to eliminate the detection of the deeper target to properly locate and identify the shallower target.

## LOW BATTERY INDICATOR:

The LOW BATT indicator will flash as the unit is powered on. If the indicator comes on and stays on, replace the batteries.





# MODES OF OPERATION

## ALL METAL MODE:



ALL METAL TOUCHPAD

There are two ways to enter the ALL-METAL mode.

- 1) Press the Disc/All Metal touch pad.  
or
- 2) Turn the detector on. (The detector always defaults to the All Metal mode when first powered on).

## DISCRIMINATION MODE:



DISC TOUCHPAD

To enter DISCRIMINATION mode,

- 1) Press the Disc touch pad, and
- 2) Turn the Disc/Notch control knob clockwise.

In the DISCRIMINATION mode, the detector will emit three distinct tones, depending on the type of metal detected.

As you turn the Disc Knob clockwise, you will progressively “discriminate out,” or eliminate from detection, different types of metals. Refer to the illustration below as a reference for the levels required to discriminate out different objects.

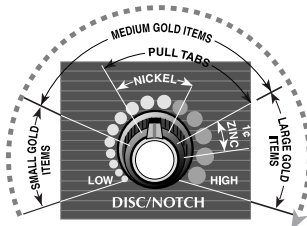

The DISCRIMINATION mode is a fixed-start-point system. As you turn the knob to the right, more objects are progressively eliminated, including the items to the left. Use DISCRIMINATION for coin-shooting and detecting in trashy areas.

If you encounter certain bothersome trash items, program their rejection into your detector as follows:

- 1) Turn the Disc/Notch knob 100% counterclockwise.
- 2) Pass the undesirable object under the search coil.
- 3) Turn the Disc/Notch knob slowly clockwise until the object is no longer detected.

## AUTO NOTCH MODE



AUTO NOTCH TOUCHPAD

To enter the AUTO NOTCH mode, press the Auto Notch touch pad. In AUTO NOTCH mode, iron, most pull tabs, and screw caps are automatically eliminated.

In addition, you can turn the Disc/Notch control to selectively eliminate more items beyond the pre-programmed ones.

You can eliminate unwanted items in the middle of the magnetic spectrum, but still retain more valuable nickels. AUTONOTCH is useful to “notch out” specific unwanted items.

# AUDIO TARGET ID

Depending on the operating mode and Disc/Notch control setting, the Lone Star emits three distinct tones which classify metal objects into categories.

## IRON & STEEL:

In the ALL/METAL mode most iron and steel objects will induce a medium tone. Highly oxidized iron can induce a high tone, in discrimination, depending on the Disc/Notch control setting. For instance, some rusted bottle caps will induce a high tone and indicate to the right of the LCD target display.

## GOLD:

In DISCRIMINATION mode, gold objects will induce a low or medium tone, depending on their sizes. Very small gold objects will indicate on the left-most segment. Large gold objects will read under the Zinc segment. If you are gold prospecting, you will usually be looking for natural gold in an area which does not contain much trash, and can therefore ignore the specific segment descriptions.

## PULL TABS:

Pull tabs are the most bothersome trash items for detectorist. Most will induce a medium tone. Most will be eliminated automatically in the AUTO NOTCH mode, or alternatively be manually “discriminated out” in DISC mode with the Disc/Notch control. The older pull tabs (those not attached to the can after opening) are sometimes broken in half; these broken tabs can induce low tones. Highly oxidized pull tabs can also induce high tones.

It can be very difficult to differentiate pull tabs from gold rings. When they both induce medium tones, you might notice a “double beep” from a gold ring but a “single beep” from pull tabs. To achieve this distinction, sweep the search coil very slowly, and at different angles. Two tones might signal as the detector passes over each side of the round ring.

## COPPER, SILVER & BRASS:

Most valuable coins are composed of these metals and will usually induce a high tone. Valuable objects other than coinage can also be composed of copper, silver and brass.

### LOW TONE



Nails & Bottle Caps,  
Gold & Nickel

### MEDIUM TONE



Old & New Pull Tabs, Zinc  
Pennies (Post 1982)

### HIGH TONE



Copper, Silver & Brass  
Copper Pennies (Pre 1982)

*Audio Target Identification (ATI) classifies metals into three categories.*

# IN THE FIELD TECHNIQUES

## PINPOINTING

Accurate pinpointing takes practice and is best accomplished by “X-ing” the target area.

1. Once a buried target is indicated by a good tone response, continue sweeping the coil over the target in a narrowing side-to-side pattern.
2. Take visual note of the place on the ground where the “beep” sounds.
3. Stop the coil directly over this spot on the ground.
4. Now move the coil straight forward and straight back towards you a couple of times.
5. Again make visual note of the spot on the ground at which the “beep” sounds.
6. If needed, “X” the target at different angles to “zero in” on the exact spot on the ground at which the “beep” sounds.

*The coil should be swung in a half-circle movement as illustrated here. Repeat this motion every step you take to guarantee that the area is being covered thoroughly.*

*When pinpointing a target, try drawing an “X”, as illustrated, over where the tone is induced.*

## COIL MOVEMENT

When swinging the coil, be careful to keep it level with the ground about one inch from the surface. Never swing the coil like a pendulum.

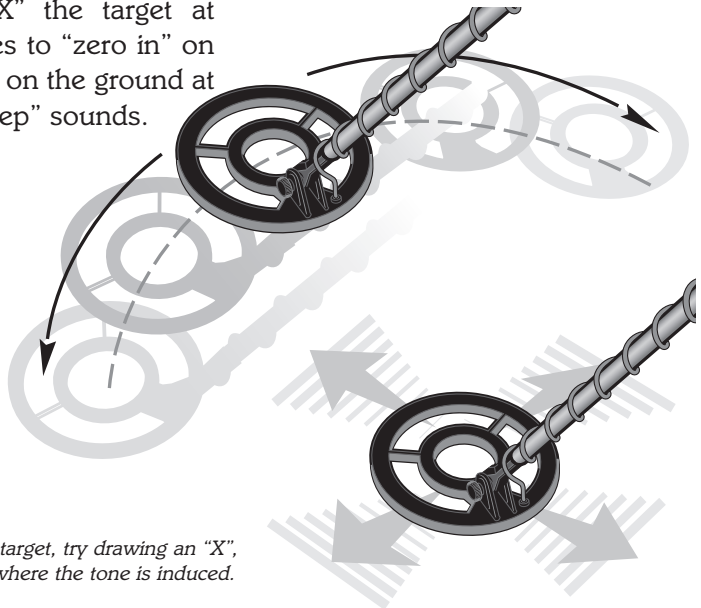
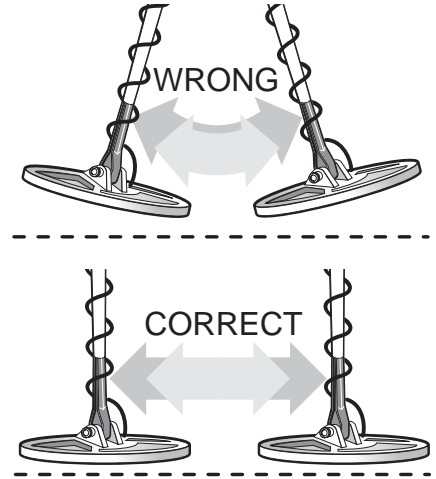

# IN THE FIELD TECHNIQUES

After selecting your operating mode, swing the search coil gently side-to-side, slightly overlapping each sweep as you move forward. Make sure you keep your search coil approximately 1 inch above the ground as you search. Raising it in the sweep, or at the ends of your sweep, will cause false readings. Move slowly; hurrying will only cause you to miss targets.

Most good objects will respond with a good repeatable signal.

If a signal does not repeat after swinging the coil directly over the suspected target a few times, it is more than likely trash metal. False signals can be caused by trashy ground, electrical interference, or by large irregular trash

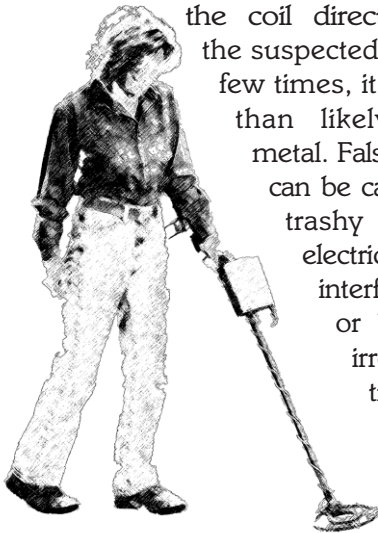

objects. These signals are easily recognized by their often broken or non-repeatable nature.

The Lone Star is a very sensitive and deep-seeking detector. It will respond loudly to many targets that other detectors would only detect with a weak signal. Because of this, trash-induced signals and other sources of interference may cause signals that seem confusing. The key to managing these false signals is to dig only those targets that emit a strong repeatable signal. As you sweep the search coil back and forth over the ground, learn to recognize the difference between the signals that occur at random and signals that are stable and repeatable.

When searching very trashy ground, it is best to scan small areas with slow, short overlapping sweeps. To prevent erratic signals and difficult pinpointing in trashy areas, consider purchasing the Bounty Hunter 4-Inch Gold Nugget Coil System.

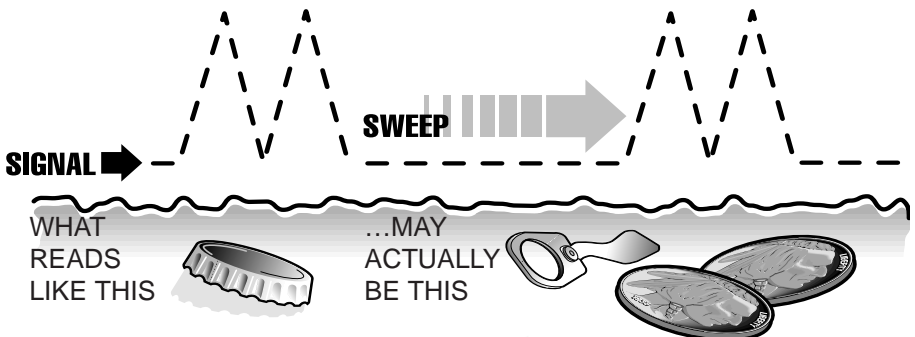

# METAL DETECTING APPLICATIONS

## COINSHOOTING:

The most popular metal detecting application. When coinshooting, you want to discriminate out pull tabs, screw caps, and iron objects. Beware that highly oxidized steel may also be detected.

### **Control settings required.**

- 1) Press DISC touch pad.
- 2) Turn the Disc/Notch Knob to the 3:00 position.

## RELIC HUNTING:

A relic is a historical object, sometimes of great value. Relics can be found in abandoned homes, plowed fields or even your own backyard. Research the local library to learn of historical events or places in the area. You can then target your search to a specific area and gain valuable insight into your local history.

### **Control settings required.**

- 1) Press DISC touchpad.
- 2) Turn the DISC/NOTCH knob 100% counterclockwise.  
Many relics are iron, so you do not want to discriminate.

## CACHE HUNTING:

A cache, pronounced "cash" is a buried or hidden valuable stored inside a case, strong box, or bag. A cache can be hidden in the floor or walls of a house, or buried nearby. Operate in the ALL METAL mode.

### **Control settings required.**

- 1) Press ALL METAL touchpad.

## JEWELRY HUNTING:

Jewelry can be found wherever people congregate. Beaches, parks, school yards and fair grounds are all littered with lost jewelry. Your greatest challenge is the interference from pull tabs and cans. You must use a discrimination mode: AUTO NOTCH is best.

### **Control settings required.**

- 1) Press the AUTO NOTCH touchpad.
- 2) Set Disc/Notch knob at 2:00. Dig only the repeatable low and high tones, avoid the broken or non-repeatable tones.

## OTHER APPLICATIONS:

Use your detector to find property markers, machine parts, and lost keys. Keep your detector in ALL-METAL mode for these tasks. Gold prospecting also requires the ALL-METAL mode.

# TROUBLESHOOTING

## TROUBLESHOOTING GUIDE

SYMPTOM	CAUSE	SOLUTION
Detector chatters or beeps erratically	<ul style="list-style-type: none"> <li>• Using detector indoors</li> <li>• Using detector near power lines</li> <li>• Using 2 detectors in close proximity</li> <li>• Highly oxidized buried object</li> <li>• Environmental electromagnetic interference</li> </ul>	<ul style="list-style-type: none"> <li>• Use detector outdoors only</li> <li>• Move away from power lines</li> <li>• Keep 2 detectors at least 30' apart</li> <li>• Only dig up repeatable signals</li> <li>• Reduce sensitivity until erratic signals cease</li> </ul>
Constant low tone or constant repeating tones	<ul style="list-style-type: none"> <li>• Discharged batteries</li> <li>• Wrong type of batteries</li> </ul>	<ul style="list-style-type: none"> <li>• Replace batteries</li> <li>• Use only 9V <b>alkaline</b> batteries</li> </ul>
LCD does not lock on to one target ID or detector emits multiple tones	<ul style="list-style-type: none"> <li>• Multiple targets present</li> <li>• Highly oxidized target</li> <li>• Sensitivity set too high</li> </ul>	<ul style="list-style-type: none"> <li>• Move coil slowly at different angles</li> <li>• Reduce sensitivity</li> </ul>
No power, no sounds	<ul style="list-style-type: none"> <li>• Dead batteries</li> <li>• Cord not connected securely</li> <li>• Not moving Searchcoil</li> </ul>	<ul style="list-style-type: none"> <li>• Replace batteries</li> <li>• Check connections</li> <li>• Sweep searchcoil from side-to-side</li> </ul>

# TREASURE HUNTER'S CODE OF ETHICS:

- Always check Federal, State, County and local laws before searching.
- Respect private property and do not enter private property without the owner's permission.
- Take care to refill all holes and leave no damage.
- Remove and dispose of any and all trash and litter found.
- Appreciate and protect our inheritance of natural resources, wildlife and private property.
- Act as an ambassador for the hobby, use thoughtfulness, consideration and courtesy at all times.
- Never destroy historical or archaeological treasures.
- All treasure hunters may be judged by the example you set; always conduct yourself with courtesy and consideration of others

## **5-YEAR LIMITED WARRANTY**

---

The **Lone Star** metal detector is warranted against defects in materials and workmanship under normal use for five years from the date of purchase to the original owner.

Damage due to neglect, accidental damage, or misuse of this product is not covered under this warranty. Decisions regarding abuse or misuse of the detector are made solely at the discretion of the manufacturer.

### **Proof of Purchase is required to make a claim under this warranty.**

Liability under this Warranty is limited to replacing or repairing, at our option, the metal detector returned, shipping cost prepaid to First Texas Products. Shipping cost to First Texas Products is the responsibility of the consumer.

To return your detector for service, please first contact First Texas for a Return Authorization (RA) Number. Reference the RA number on your package and return the detector within 15 days of calling to:

### **First Texas Products L.L.C.**

1465-H Henry Brennan Dr.  
El Paso, TX 79936  
Phone: 915-225-0333

### **NOTE TO CUSTOMERS OUTSIDE THE U.S.A.**

This warranty may vary in other countries, check with your distributor for details.  
Warranty does not cover shipping costs.

According to FCC part 15.21 Changes or Modifications made to this device not expressly approved by the party responsible for compliance could void the users authority to operate this equipment.

Copyright© 2012 by First Texas Products, L.L.C.

All rights reserved, including the right to reproduce this book, or parts thereof, in any form, except for the inclusion of brief quotations in a review.

Published by First Texas Products, L.L.C.  
Bounty Hunter® is a registered trademark of First Texas Products, L.L.C.

[www.detecting.com](http://www.detecting.com)



1465-H Henry Brennan • El Paso, TX 79936 • (915) 633-8354

# ACCESSORIES

## Carry Bag .....\$ 29.95

Rugged double-stitched construction - *CBAG-W*

## Pouch & Digger Combo .....\$ 24.95

Pouch with 2 large pockets & 9" heavy duty digging tool. *TP-KIT-W*

## Bounty Hunter Stereo Headphones.....\$ 39.95

Use with Bounty Hunter metal detectors. Lightweight and adjustable with true stereo sound, adjustable volume, 1/8 jack with 1/4 adaptor, 4' cable. *HEAD-W*

## Pin Pointer .....\$ 69.95

Pinpoints the exact location of buried metal objects. Audio signal indicator and vibrator. Runs on 1 – 9-Volt Battery. *PIN POINTER-W*

## Sand Scoop.....\$ 24.99

Large scoop with filtering holes. Made of strong plastic. *SAND SCOOPBH*

## Coil Covers

Protect your coil from abrasion and damage.

10" Coil Cover – *10COVER*.....\$19.99

8" Coil Cover – *8COVER-N*.....\$19.99

4" Coil Cover – *4COVER*.....\$14.99

## Replacement/Accessory Search Coils

10" Magnum Coil – *10COIL*.....\$69.95

8" Replacement Standard Coil – *8COIL-N*.....\$49.95

4" Gold Nugget Coil – *4COIL*.....\$39.95

## 9" Heavy-Duty Digging Tool.....\$ 10.95

Metal blade with comfortable plastic handle and depth gauge *TROWEL-2*

## Digging Tool .....\$ 7.95

Light and practical wide blade digging tool. *TROWEL-W*

## Bounty Hunter T-Shirt .....\$ 19.99

100% cotton with Bounty Hunter® Logo. Sizes – LG, XL & XXL

## Bounty Hunter Baseball Cap .....\$ 14.95

One size fits all, with Bounty Hunter® logo.

## Gold Prospecting Kits

### Items Included:

	<b>Gold Kit</b> PART NUMBER: GOLDKIT1 \$ 39.99	<b>Deluxe Kit</b> PART NUMBER: GOLDKIT2 \$ 79.99	<b>Hardrock Kit</b> PART NUMBER: GOLDKIT3 \$ 149.99
10 1/2" Gold Pan	x	x	x
14" Gold Pan	x	x	x
Classifier		x	x
2 – Shatterproof Vials	x	x	x
Snuffer Bottle	x	x	x
Black Sand Magnet		x	x
Treasure Scoop		x	x
Tweezers			x
Magnifier			x
Crevice Tool			x
Rock Pick			x
Instruction Booklet	x	x	x
Backpack		x	x

FOR COMPLETE DETAILS VISIT [WWW.DETECTING.COM](http://WWW.DETECTING.COM) • 1-800-413-4131

